

# D PROFI

DECESPUGLIATRICI IDRAULICHE PER AREE VERDI | HYDRAULIC HEDGE CUTTERS FOR GARDENS MAINTENANCE

MOD : D 500 | D 620

- Scambiatore di calore | *Oil cooler*
- Ammortizzatore idraulico autoritornante con accumulatore oleopneumatico  
*Hydraulic self-reversing shock absorber with Oleo-pneumatic accumulator*
- Articolazioni principali con elementi stampati e boccole autolubrificate  
*Main joints with printed parts and self lubricate bushings*
- Trasmissione dell'albero rotore con moncinghia e puleggia dentata  
*Single toothed belt drive transmission with toothed pulley*
- Rotore bidirezionale | *Reversible rotor*
- Impianto idraulico ad ingranaggi ad alta potenza: 52 CV di potenza al rotore  
*High performance hydraulic system: 52 HP power to the rotor*
- Pompa 61 cm<sup>3</sup> e motore 51 cm<sup>3</sup>  
*Pump 61 cm<sup>3</sup> and engine 51 cm<sup>3</sup>*



## UTENSILI | TOOLS

STANDARD  
COLTELLO Y  
Y FLAILS



MAZZA  
HAMMER



PLUS  
COLTELLO Y  
Y FLAILS



MAZZA BIDIREZIONALE  
BIDIRECTIONAL HAMMER



SU RICHIESTA  
ON REQUEST

## CARATTERISTICHE | FEATURES

STANDARD



Accumulatore oleopneumatico  
*Oleo-pneumatic accumulator*

PLUS









Impianto idraulico  
ad ingranaggi  
*hydraulic system*



Comandi a cavi flessibili  
*Flexible cable controls*



Comandi elettrici  
*Electronic controls*

SPECIFICHE TECNICHE   TECHNICAL SPECIFICATIONS			
MODELLO   MODEL		D 500	D 620
	LARGHEZZA LAVORO WORK WIDTH (cm)	120	120
	LUNGHEZZA TOTALE TOTAL LENGTH (cm)	500	620
	PESO WEIGHT (Kg)	1100	1150
	MAX Ø DI TAGLIO MAX CUTTING Ø	7/8	7/8
	N° MAZZA BIDIREZIONALE e COLTELLI BIDIRECTIONAL HAMMER and KNIFE	18   36	18   36
	SCATOLA STANDARD STANDARD GEARBOX	80-100	90-110

RIF.		D 500	D 620	
SPOSTAMENTO LATERALE (mm) SIDE OFFSET (mm)	A	Sbraccio massimo orizzontale Max. horizontal reach	4800	6000
	B	Altezza massima verticale Max. vertical height	4900	6100
	C	Sbraccio massimo su pendio a a 45° Max. reach on a 45° slope	4600	5800
	D	Sbraccio massimo su fossato a 45° Max. reach on a 45° ditch	4700	5900
	E	Altezza massima in posizione orizz. Max. height in horizontal position	2800	4300

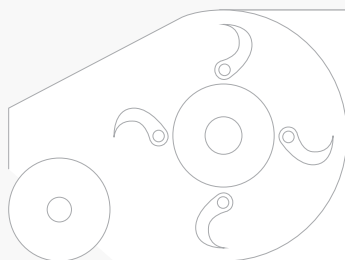

Ø del rotore   Ø of rotor	140 mm
Giri rotore   RPM	3100 g/min
Presa di forza   PTO	540
Ø del rullo   Ø of roller	110 mm

### VERSIONE STANDARD | STANDARD VERSION

COMANDI A CAVI | ALBERO CARDANICO | TENDITORI | SCAMBIATORE DI CALORE  
| KIT LUCI

CABLE CONTROLS FOR MOVING | PTO SHAFT | STABILIZERS  
OIL COOLER | ROAD LIGHTING KIT



### VERSIONE PLUS | PLUS VERSION

COMANDO ELETTRO-PROPORZIONALE CON SISTEMA AUTOLIVELLANTE ROTORE  
ELICOIDALE | ALBERO CARDANICO | TENDITORI | SCAMBIATORE DI CALORE | KIT LUCI

ELECTRIC-PROPORTIONAL CONTROL WITH SELF-LEVELLING SYSTEM | HELICOIDALLY  
ROTOR | PTO SHAFT | STABILIZERS | OIL COOLER | ROAD LIGHTING KIT

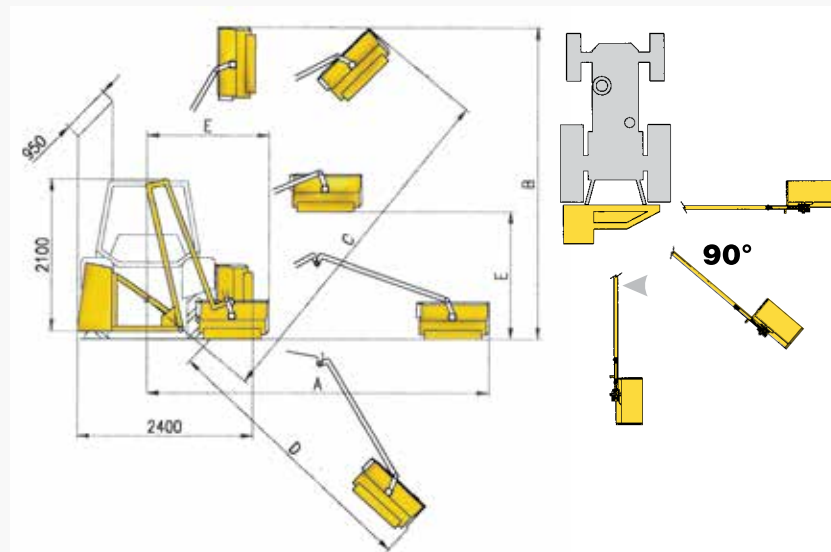

## OMARV

Via Abbate 215, Castagnole delle Lanze 14054 (AT) - Italy

Tel. +39 0141 877368

info@omarv.com - www.omarv.com